



Conversion Kit Installation Instructions

● For TOYOTA 2JZ Vehicles ●



株式会社 エッチ・ケー・エス
〒418-0192 静岡県富士宮市北山7181
<http://www.hks-power.co.jp/>

禁無断複写・転載
Unauthorized reproduction is strictly prohibited.

改訂No.	発行日	品番
MS-1-1	2020/3/12	E31200-T00040-00

Thank you for purchasing HKS × ORC clutch kit.

※ This clutch kit is identical to ORC item, part number ORC-1000F-01T.

● NOTICE ●

- This manual explains correct installation and use of the product. Please read this manual prior to installation.
- Details of this manual that require special caution are marked in bold.
- Please keep this installation manual while using the product.
- This manual should be passed to the user of the product.

● SAFETY PRECAUTIONS ●

The following precautions for use of this product are to prevent possible accidents and/or injuries and for proper use.

 警告	Indicates risk of serious injury and/or possible death.
---	---

 注意	Indicates risk of serious injury and/or possible property damage (i.e. vehicle damage from use of this product).
--	--

● For TOYOTA 2JZ Vehicles ●

Kit includes

- Release fork ● Clutch release dust cover ● Fork supporter ● Release cylinder
- Cylinder bracket ● Hinge pin(φ 12) ● Retainer plate
- Wave washer ● Hose band ● Bearing/Sleeve assembly.
- Clutch hose ● Copper washer
- Bolt set for Clutch release support M10 × 20 (2)
- Bolt set for release cylinder: M10 × 30 (2) and Plate washer (2)
- Bolt set for cylinder bracket : M8 × 60 (1), M8 × 20(1) and Plate washer (2)

The release cylinder contains an adjustable pushrod.
The length of the adjustable pushrod is set to 73mm at the time of shipment. The piston in the cylinder is located at the proper position during installation.

Adjust the length as necessary, referring to the figure on the right. If the clutch disc wears, the piston position in the cylinder will change. Adjust the piston in the cylinder to the position shown in the figure on the right as needed.

Recommended cylinder stroke: 18mm

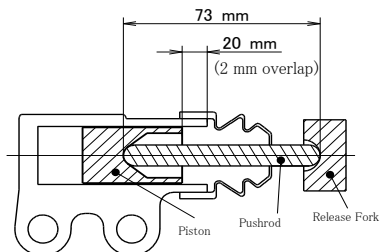

■ See each Fig and follow the steps below for installation.

1. Remove the transmission according to the maintenance instructions.
2. Remove the stock release cylinder with the hose from the flare nut.(see Fig. 4)
3. Remove the stock release fork and clutch release support in the transmission housing.
4. The removed parts are not used and should be kept in a safe place.

- 注意

 5. Clean the front cover inside the transmission housing and apply molybdenum grease to the entire protruding part.
- 注意

 6. There are white markings on the fork supporters. Fix the markings with the bolts facing the center. Hexagon socket head bolt M10 × 20 : 2pcs.Tightening torque: 49.0 N.m (5.0 kgfm)(See Fig.1)
- 注意

 7. Apply molybdenum grease to the entire inside diameter of the Bearing/Sleeve assembly and fit it on the front cover.
- 注意

 8. Apply molybdenum grease to the rubbing point of the release fork with the fork supporter and the bearing / sleeve assembly.
- 注意

 9. Apply molybdenum grease to the hinge pins, and install the release fork to the fork supporter. At the same time, the flat part of the sleeve should face the fork and the mounting part of the release fork enters the flange of the bearing/sleeve assembly. (See Fig. 2)
- 注意

 10. Insert the hinge pin into the release fork and fork supporter with the wave washer attached with the collar on the upper side of the transmission housing, and fit the retainer plate into the groove of the hinge pin. (See Fig. 3)
11. Install the transmission in the vehicle according to the maintenance manual.
- 注意

 12. Insert the clutch release dust cover between the cylinder bracket and the transmission housing, and tighten them together with the attached bolts. As a basis for converting from pull type to push type. Tightening torque for both M8 x 60 and M8 x 20: 16.7 to 19.6 N.m (1.7 to 2.0 kgfm) (See Fig. 4)
- 注意

 13. Insert the clutch hose with a copper washer and connect it to the release cylinder. Clutch hose tightening torque: 16.7 to 19.6 N.m (1.7 to 2.0 kgfm) (Fig. 4)
- 注意

 14. Apply molybdenum grease to the point where the push rod of the release cylinder fits onto the release fork, and install the release cylinder to the cylinder bracket. At that time, be sure the pushrod does not separate from the release fork. Hexagon socket head cap screw M10 x 30 [2 places] Tightening torque: 42.2-47.1N.m (4.3-4.8kgfm) (See Fig. 4)
- 注意

 15. Insert the clutch hose into the bracket fixed on the vehicle body side. Tighten the flare nut, and fix with the attached hose band. Flare nut tightening torque: 14.7 to 17.7 N.m (1.5 to 1.8 kgfm) (See Fig. 4)
- 注意

 16. After installation, bleed the air from the release cylinder.

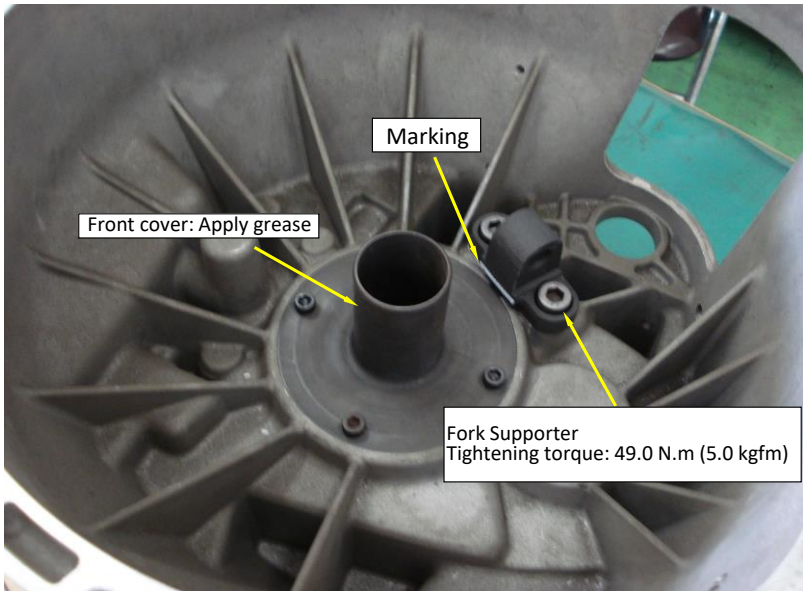

Fig. 1

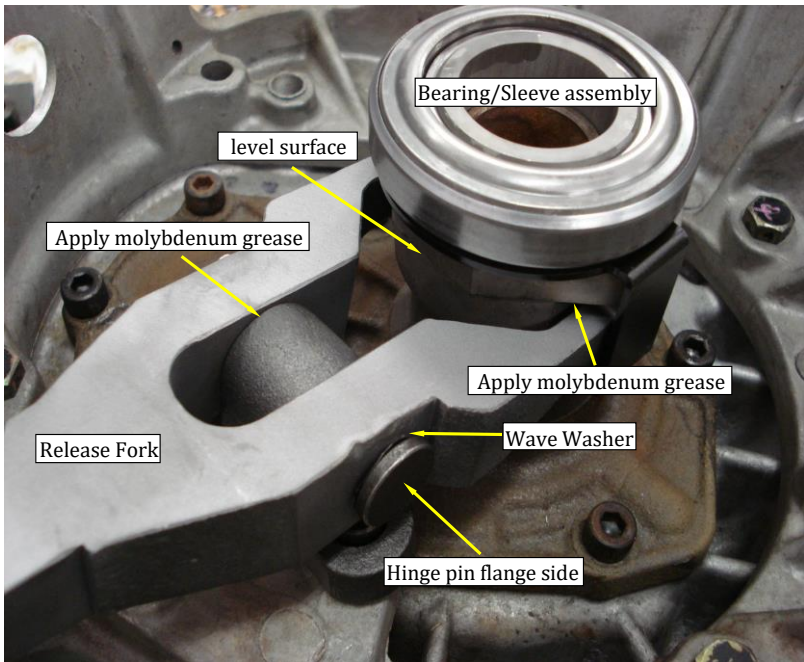

Fig. 3

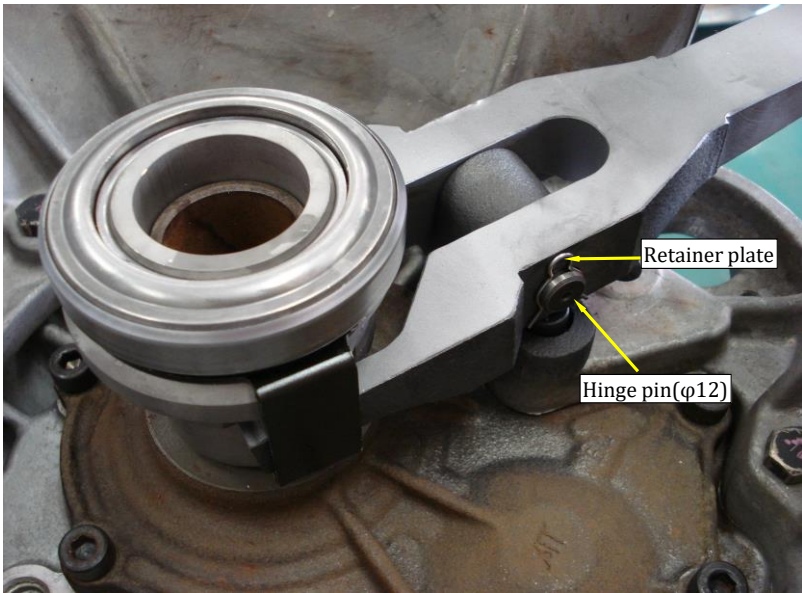

Fig. 2

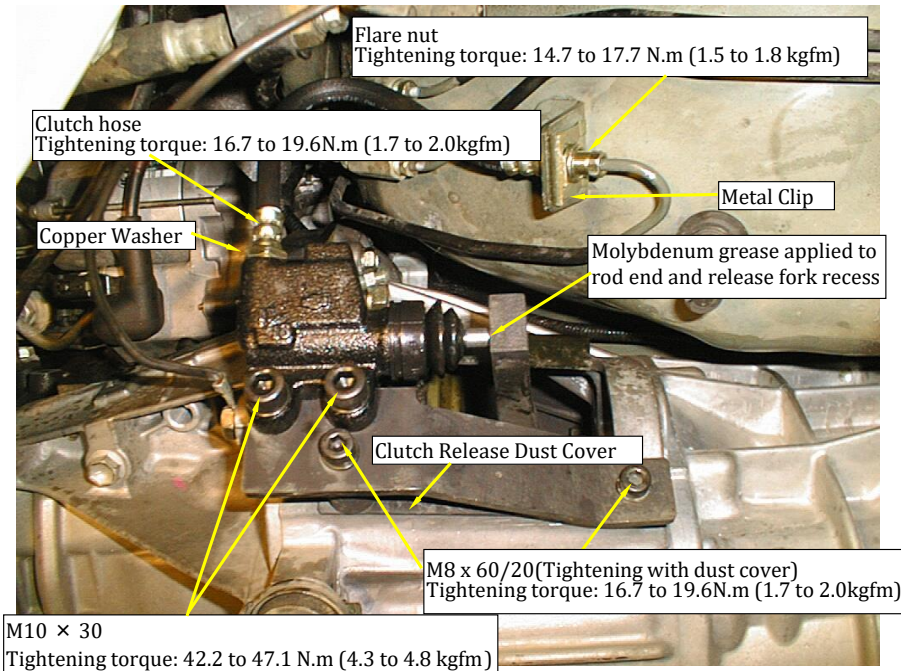
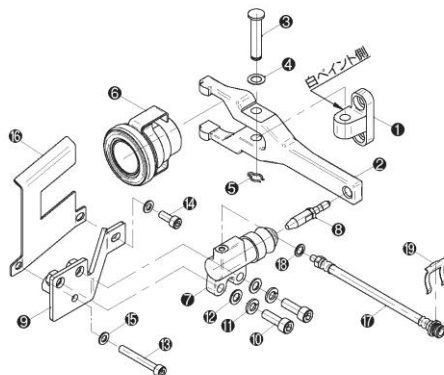

Fig. 4

● Parts configuration diagram ●

**01T,
TT0101
用**

構成 部品表	No.	名称	数量	樹括	税込
		専用交換キット			
	①	サボート	1		
	②	リリースフォーク	1		
	③	ヒンジピン	1		
	④	ウェーブワッシャー	1		
	⑤	止め輪	1		
	⑥	スリーブベアリングAssy	1		
	⑦	リリースシリンダー	1		
	⑧	調整式プッシュロッド	1		
	⑨	シリンダステー	1		
	⑩	六角穴付きボルトM10×30	2		
	⑪	スプリングワッシャー	2		
	⑫	平ワッシャー呼び10	2		
	⑬	六角穴付きボルトM8×60	1		
	⑭	六角穴付きボルトM8×20	1		
	⑮	平ワッシャー呼び8	2		
	⑯	ダストカバー	1		
	⑰	クラッチホース	1		
	⑱	銅パッキン	1		
	⑲	ホース止めクリップ	1		



※専用交換キットはセットのみの販売となります。 ※⑥スリーブベアリングAssy以外の部品は単品での販売を行っておりません。









No	Name	Quantity
1	Fork supporter	1
2	Release fork	1
3	Hinge pin(φ 12)	1
4	Wave washer	1
5	Retainer plate	1
6	Bearing/Sleeve assembly.	1
7	Release cylinder	1
8	Variable push rod	1
9	Cylinder bracket	1
10	Bolt set for release cylinder: M10×30	2
11	Spring washer	2
12	Spare Plate washer for M10	2
13	Bolt set for cylinder bracke M8x60 long	1
14	Bolt set for cylinder bracke M8x20 short	1
15	Spare Plate washer for M8	2
16	Clutch release dust cover	1
17	Clutch hose	1
18	Copper washer	1
19	Hose band	1

*The special replacement kit is sold only as a set.

*Only bearing / Sleeve assembly is sold separately.

]

● SAFETY PRECAUTIONS ●

-  ● After installation, driving carefully and gently is necessary. (drive for approximately 500 km in city) Aggressive driving before friction surface fully contacted with the mating surface will cause burning partly, judder or short life.
-  ● **Vehicles that have been converted from automatic to manual transmissions may not have dowel pins (knock pins) for determining position the engine and clutch housing. Absence of this pin, can cause damage to conversion kit or cause malfunction. Make sure that the pin is inserted. For vehicles that were automatic, remove the plate between the crank surface and the FW ring gear as the mounting position of the clutch changes and it may not perform properly.**
-  ● Perform regular maintenance of the conversion kit.
-  ● The conversion kit is a consumable item. If the original performance cannot be achieved due to friction damage, replace it.
-  ● Please replace the release bearing during overhauling clutch. Please also check the position and abrasion between clutch disk and pressure plate. Replacement is necessary if uneven wear is noticed (approximately 0.1mm worn). If the diaphragm springs of clutch cover Assy have damages or deterioration, please replace the clutch cover Assy. Without such replacement, performance can not be guaranteed.
-  ● Due to the features of our metal clutch, feeling of control half clutch will be affected depending on the pedal position changing after installation. It is recommended to re-adjust clutch engage point after running-in.
-  ● If using half clutch a lot, the clutch set will get high temperature and creates expansion or deformation which causes disengagement problems temporarily or permanently. Please do not drive until cooling down.
-  ● High torque capacity clutch has a lightweight design compared to stock and may have rattle sound from transmission could be heard. Especially for the high torque engine, the rattle sound will be louder than normal in the power band. Using high viscosity transmission fluids can reduce the sound, but it's impossible to remove it completely as the cause is mechanical.
-  ● This clutch system is designed only for racing purposes, therefore pedal effort is slightly heavier and taking off might be more difficult than on a stock vehicle and requires a lot of practice. Please note that before driving.

● Frequently Asked Questions ●

If you have questions about HKS products, please access "Support" page from URL below for further information.

<https://www.hks-power.co.jp/>